

NORMA[®]

by UNIDOORS



COLLECTIONS

Index

1. Overview	2
1.1. About us	2
1.2. Our factories	2
1.3. Certification	3
2. Our doors	4
2.1. Lacquered doors collections	4
2.2. Laminated doors collections	10
2.3. Natural veneer doors collections	15
3. Wardrobes	17
4. Technical features	19
4.1. Types of core	19
4.2. Types of groove	20
4.3. Types of inlay	20
4.4. Types of glazing	20
5. Technical doorsets	21
6. Other components	23
6.1. Frames and architraves	23
6.2. Ironmongery	25
6.3. Other	26
7. Selected projects	27

1.3. Certification

We are committed to quality, safety and sustainability. That is why our certifications reflect our dedication to excellence and position us as the best choice for our clients, supporting both our standard solutions and our custom projects for hotels, public buildings, hospitals, offices, residential developments, and more.

We hold the Certifire by Warrington certification and the UKTC United Kingdom Testing & Certification Ltd., ensuring that our fire-rated doors (FD) meet the required fire resistance regulations. This guarantees a reliable and secure solution for any type of building.

Our doors also comply with the Certisecure certification, accredited by Warringtonfire. This ensures compliance with the British PAS 24 standard, which establishes resistance and security requirements recognized by the British police. This provides reassurance and peace of mind for every project.

In addition, our doors carry the Aenor N Brand, certifying the technical and manufacturing quality of our products.

All our factories are ISO 9001 certified, guaranteeing excellence in Quality Management across every production process. We also hold the IQNET certificate, which supports the international recognition of our management system.

Furthermore, we are proud to hold the ISO 14001 certification for Environmental Management Systems (EMS), as well as the PEFC and FSC® certifications, ensuring that our products come from sustainable and environmentally responsible sources, actively contributing to the protection of the planet.



2.1. Lacquered doors collection - *Byzantine*



PANT 3*

IN 2

IN 3

PANT 8*

PANT 7*



Most of our doors can be customised with glazing. See the possible options in section 4.4. Types of glazing.

* The Pant 5, Pant 6, Pant 3, Pant 8, Pant 7, 3R and 3Z models can be manufactured with different types of grooving. You can consult them in section 4.2.

2.1. Lacquered doors collection - *Lithuanian*



U12



U03



U22



U04



F2 R



Most of our doors can be customised with glazing. See the possible options in section 4.4. Types of glazing.

2.1. Lacquered doors collection - *Burgundian*



PANT 3R*



PANT 3Z*



PANT S



PANT A



SIEVE



FLEMISH



GALLEON



YOKE



LOOM



Most of our doors can be customised with glazing. See the possible options in section 4.4. Types of glazing.

* The Pant 5, Pant 6, Pant 3, Pant 8, Pant 7, 3R and 3Z models can be manufactured with different types of grooving. You can consult them in section 4.2.

2.1. Lacquered doors collection - *Incan*



OFLYN 2S



OFLYN S



OFLYN 4C



OFLYN 1C



OFLYN 2C



SLINGER



Most of our doors can be customised with glazing. See the possible options in section 4.4. Types of glazing.

2.1. Lacquered doors collection - **Celtic**



MOLDED 6P - 6PS



MOLDED 3P



MOLDED 2P



MOLDED 5P



MOLDED 2PC



MOLDED 4P



 Textured

Smooth

2.1. Lacquered doors collection - **Finishes**

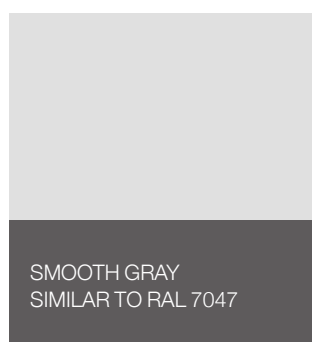
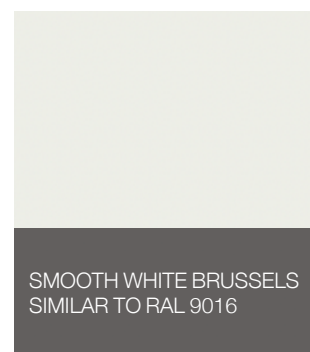
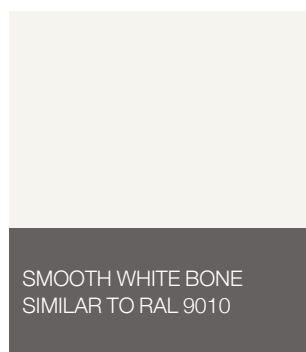
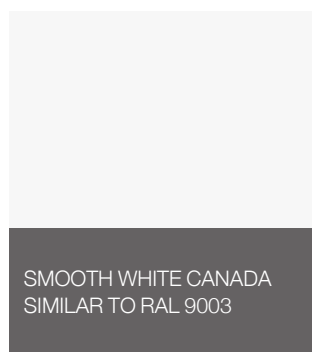
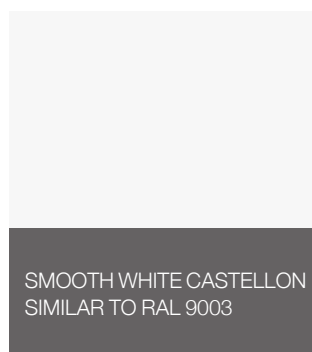

Priming: designed for those who wish to finish the door on-site or in their workshop.

Industrial Lacquering: this is our standard lacquering process, which is highly appreciated by the vast majority of our customers for its impeccable results. We apply three base coats with intermediate sanding between each, ensuring optimal adhesion, followed by a topcoat that provides a flawless finish.



For technical reasons, the images shown in this catalogue may differ from the original designs.

2.2. Laminated doors collection - *Roman*



OCAÑA OAK

VERTICAL



OCAÑA OAK

HORIZONTAL



JARAMA OAK

PANT 5 HORIZONTAL



LIGHT OAK

IN 2 VERTICAL



YEPES OAK

IN 3 HORIZONTAL



YEPES OAK

Available models to combine with some of the laminated finishes on pages 12, 13, and 14. Check available options for each model. Most of our doors can be customised with glazing. See the possible options in section 4.4. Types of glazing.

2.2. Laminated doors collection - *Magyar*



JARAMA OAK

FORGING



LIGHT CHESTNUT

HUSSAR



CASAREJOS ELM

RECURVE



JARAMA OAK

CORVINIAN



JARAMA OAK

PIERCING



WHITE SKY OAK

2.2. Laminated doors collection - **Basic** laminates

B

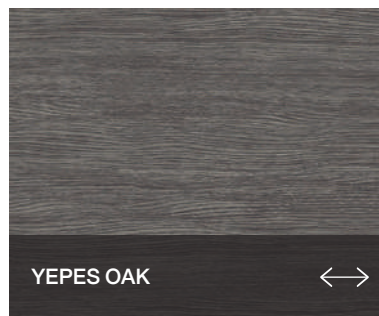
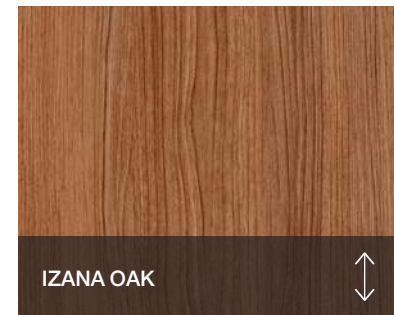
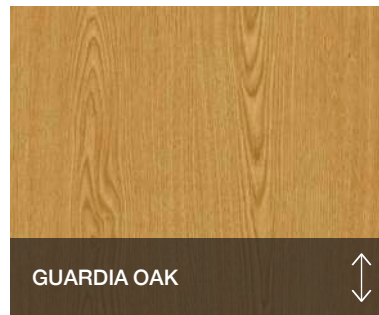
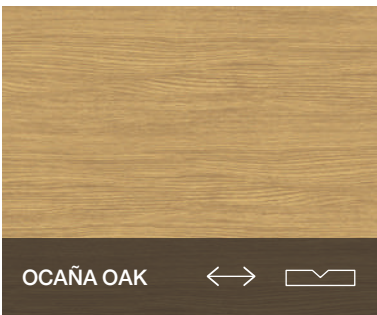
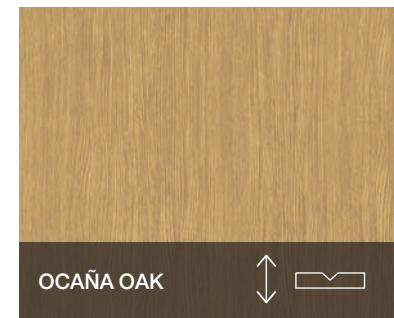
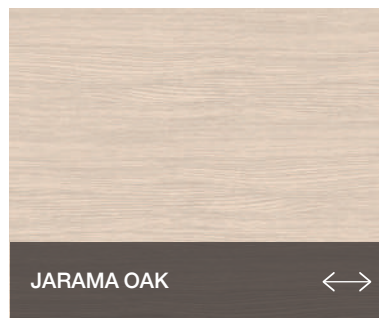
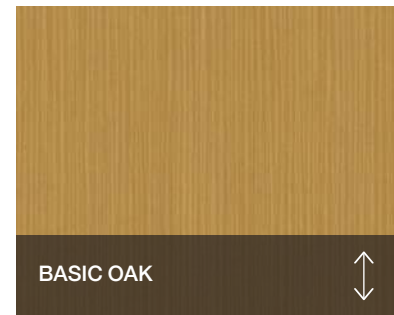
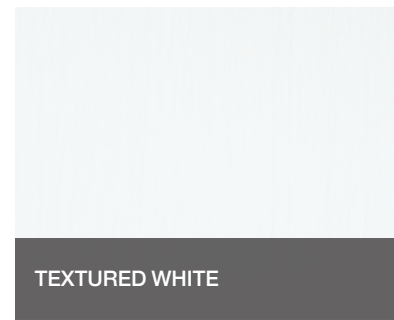
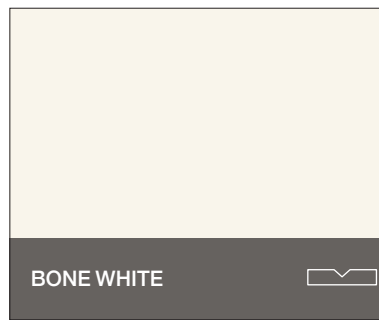
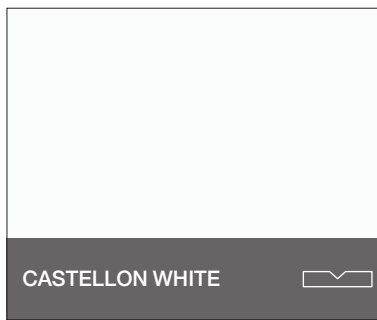

  The arrow indicates the direction of the grain.

 Available with lines of the same color for pant-5.

For technical reasons, the images shown in this catalogue may differ from the original designs.

2.2. Laminated doors collection - **Concept** laminates

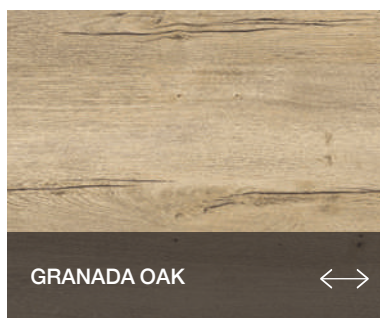
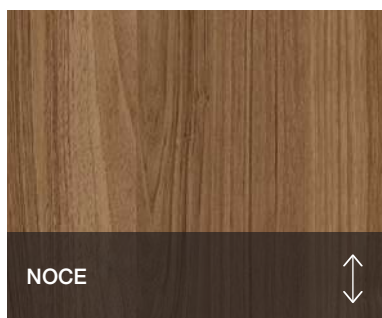
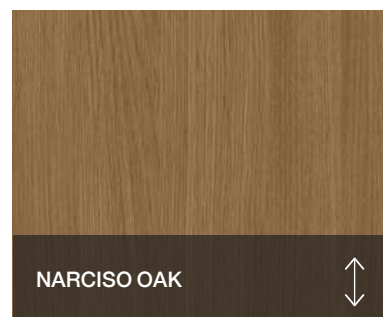
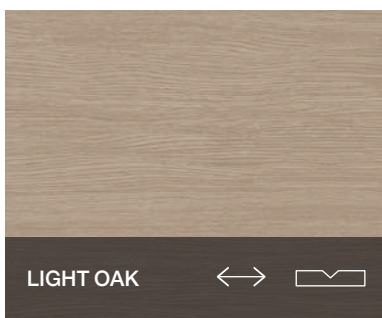
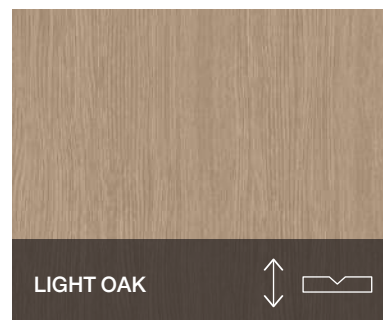

2.2. Laminated doors collection - **Plus** laminates

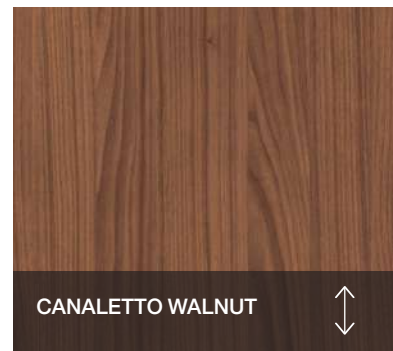
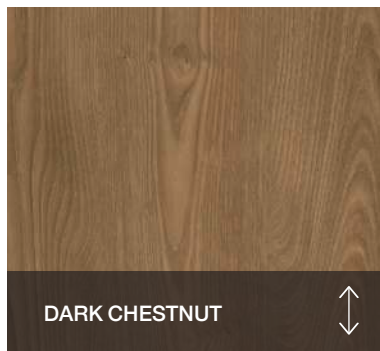
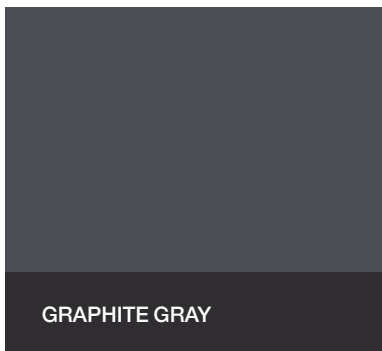
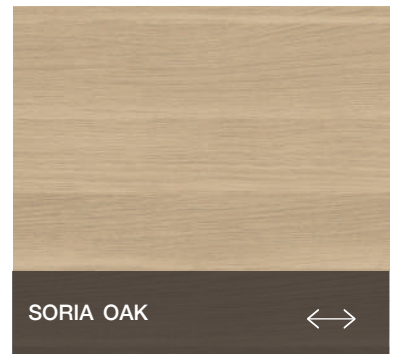
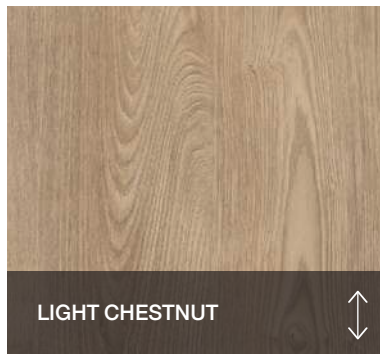

Check the most up-to-date laminate options.

↕ ↔ The arrow indicates the direction of the grain.

▭ Available with lines of the same color for pant-5.

For technical reasons, the images shown in this catalogue may differ from the original designs.

2.3. Natural veneer doors collection - *Slavic*



WALNUT

VERTICAL



BEECH

FAJA



BEECH*

HORIZONTAL



WENGE

HACHE



WALNUT

Available models to combine with the natural wood veneers on page 16. Check available options for each model.

(*) The more reddish tone of Beech is achieved through steaming, a common technique used on this wood species to reduce its risk of warping. Most of our doors can be customised with glazing. See the possible options in section 4.4. Types of glazing.

2.3. Natural veneer doors collection - **Finishes**

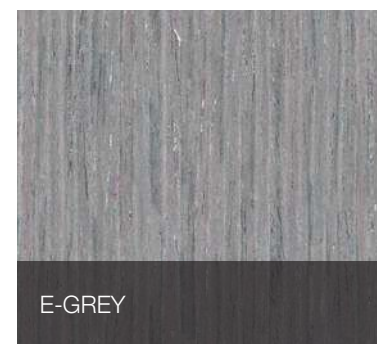
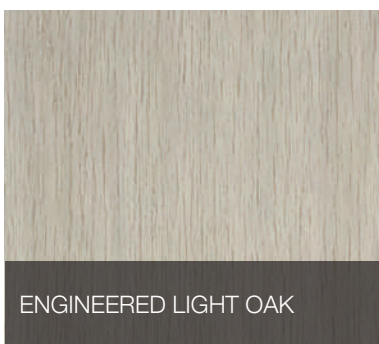
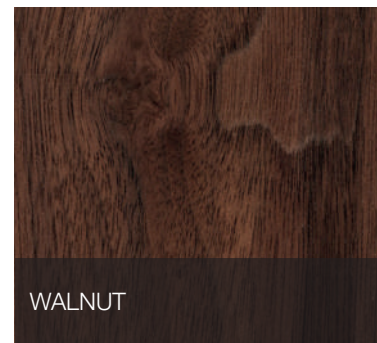
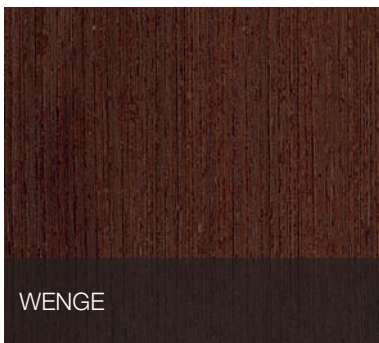
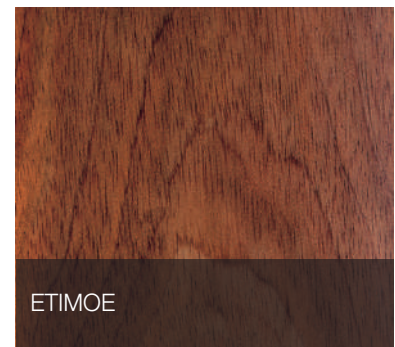
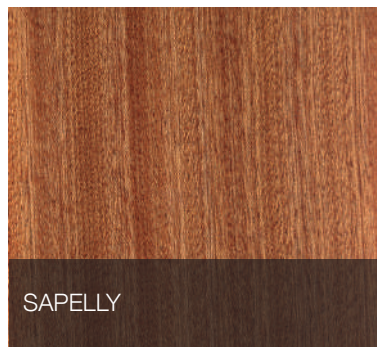
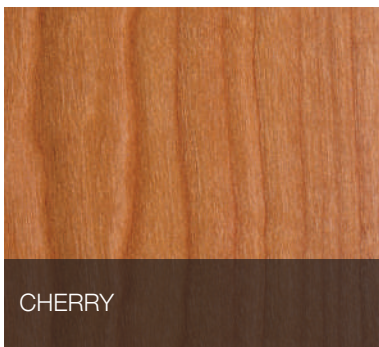

3. Wardrobes

We have the capability to manufacture wardrobes with swing and sliding doors. We can make: just the doors, the complete front (doors + frame), or the entire wardrobe (including the interior).





Through a suitable combination of dimensions and opening types (swing and sliding doors), our range of cabinets meets all the needs of new construction and renovation projects.

4.1. Types of core



Solid Core



Tubular Core



EPS Core

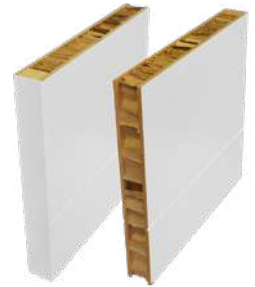

Hollow Core

4.2. Types of groove

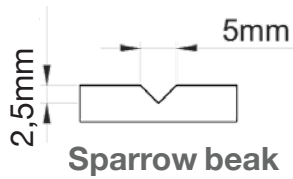

Sparrow beak

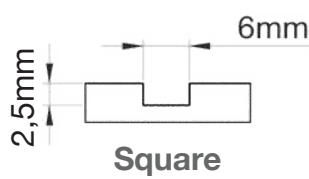

Square



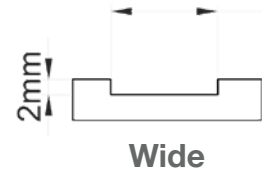

Available in 10mm and 30mm

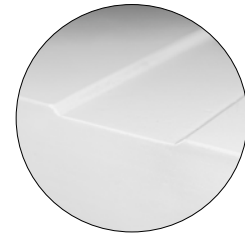

Wide



				
Models		Sparrow beak	Square	Wide
Lacquered	Pant-5	✓	✓	✓
	Rest	✓	✓	✓
Laminates	Pant-5	Whites, Oaks, Beech		
	Rest	Only Magyar collection		
Veneer	Pant-5	✓		
	Rest	✓		

4.3.Types of inlay

EXCLUSIVE TO PANT5 DESIGN



4.4.Types of glazing

We adapt the type of glazing to the door design according to your preference.
Our technical department designs the type of window that best fits the selected door model.

Standard

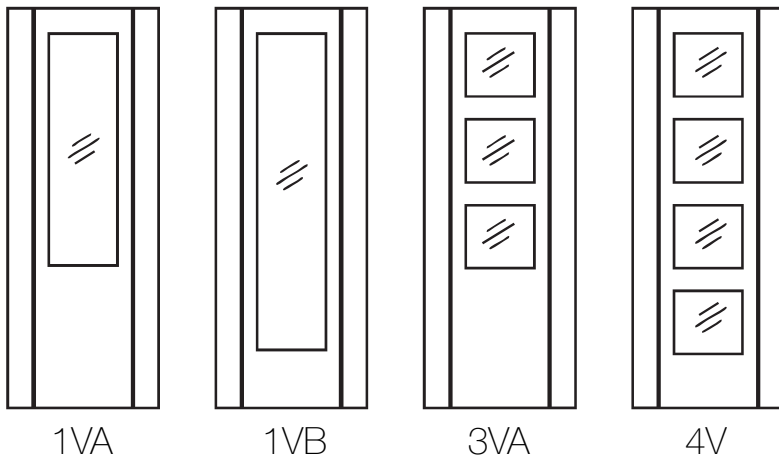

Special

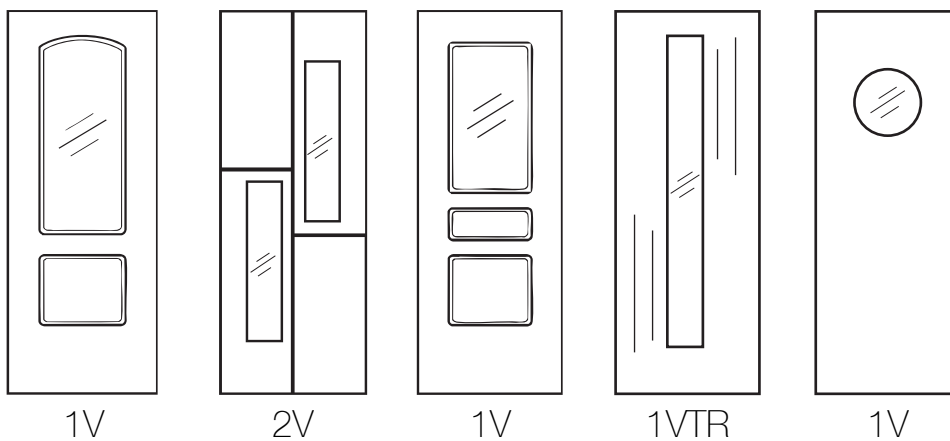

Fire and acoustic doors

We are committed to developing doors that deliver the highest levels of safety, performance, and comfort.

We hold the Certifire by Warringtonfire certification and the UKTC United Kingdom Testing & Certification Ltd., which ensure that our fire-rated doors (FD) meet the required fire resistance regulations, providing a reliable and secure solution for any building.

Among our core products are fire-rated doors tested for 30, 60, and 90 minutes of fire resistance. In addition, they provide excellent acoustic insulation, ranging from 21 to 42 decibels (Rw).

Our doors also comply with the Certisecure certification by Warringtonfire. This guarantees compliance with the British PAS 24 standard, which establishes resistance and security requirements recognized by the British police.



30, 60, 90 min.
BS 476 - UNE EN1634 - 1



RW=21dB - RW=42dB

Fired rate doors	Acoustic rating (Rw)			
30	31	34	40	42
60	33	34	36	
90	34			

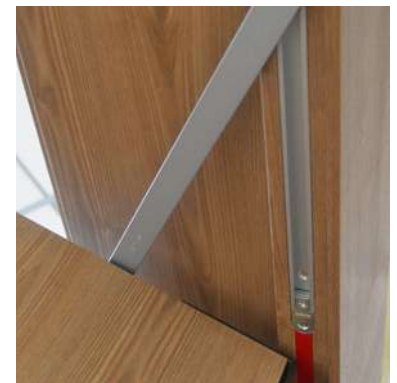
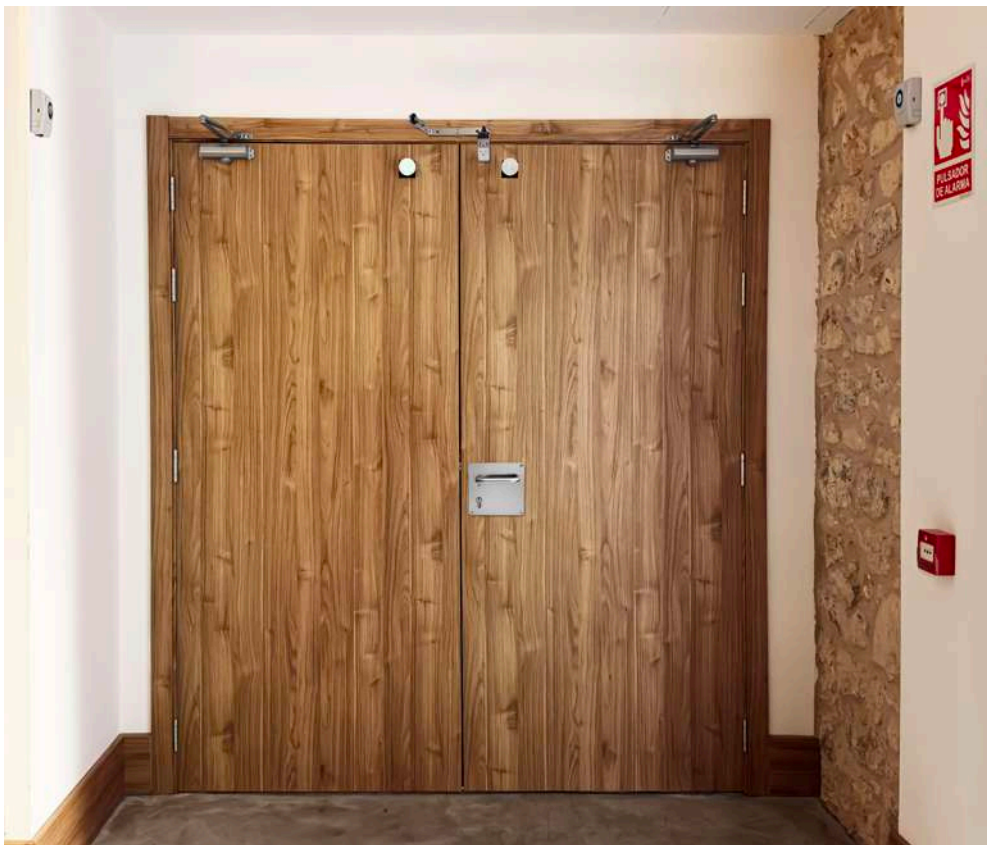

Concealed door closers



Drop-down seal



Technical and standard doors for hotels and more

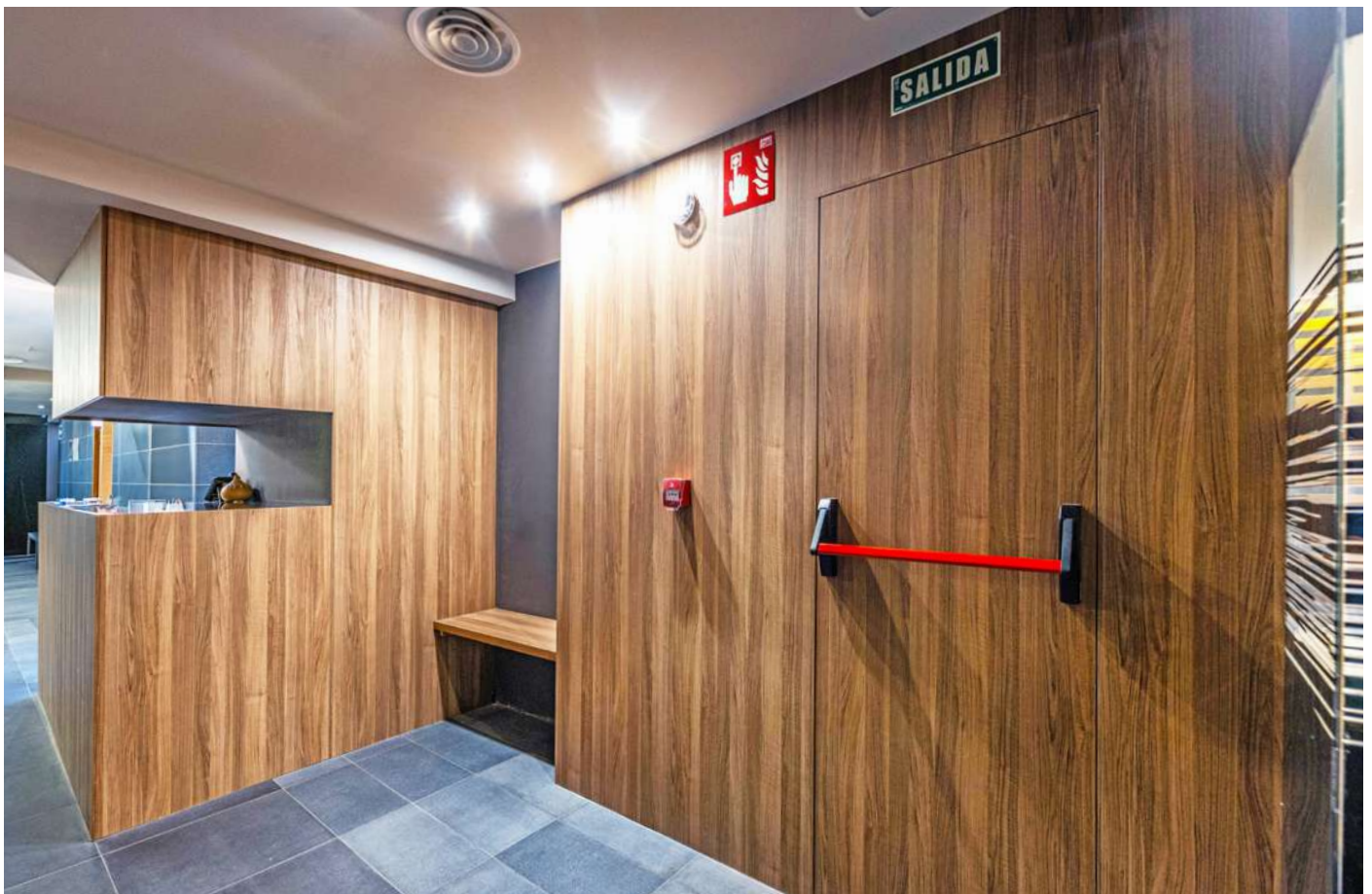

6.1. Frames and architraves

Types of **core**

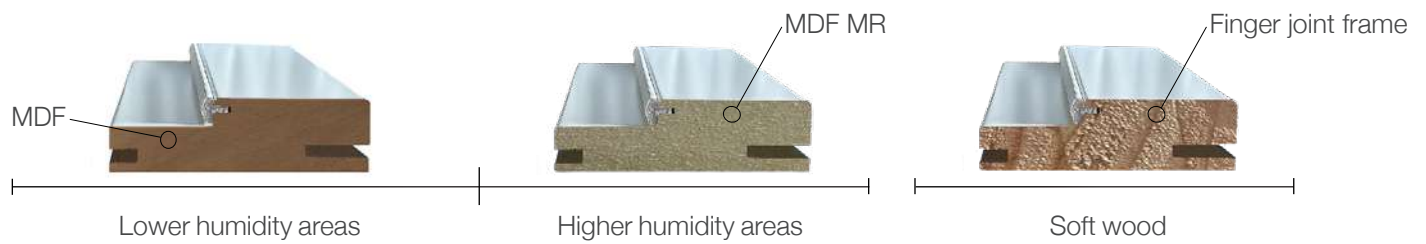

Fixed Measurement **Settings**

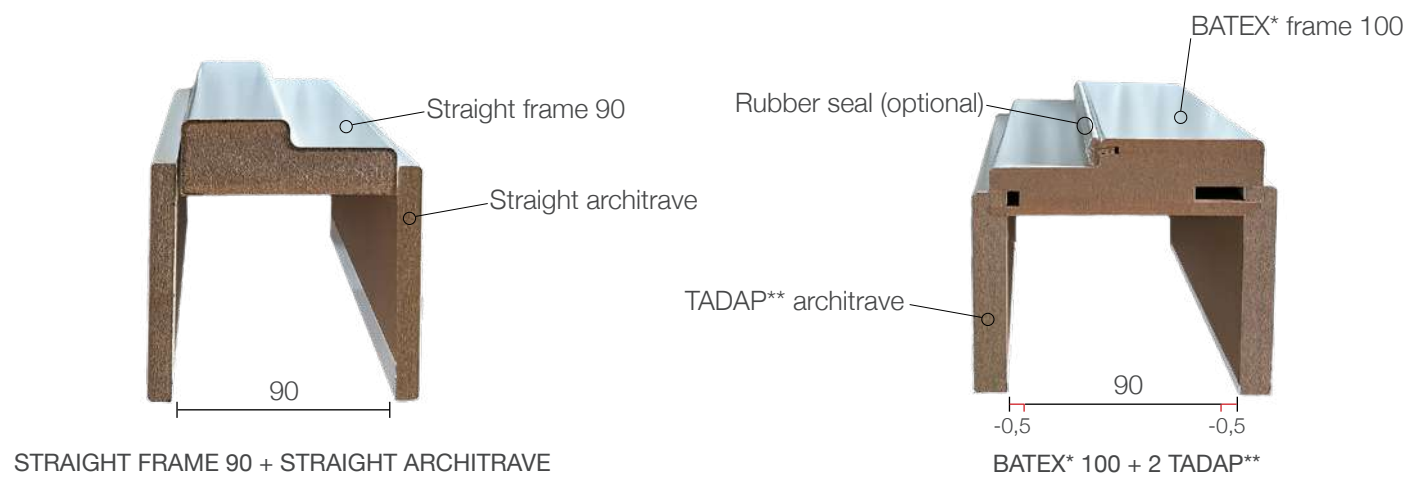

Planted **stop**

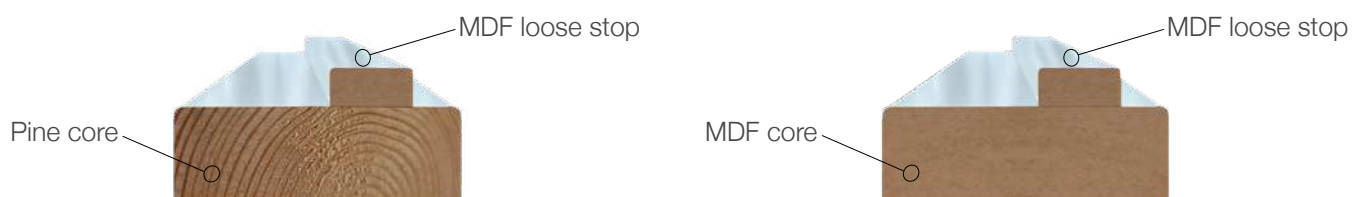

Hard wood - **PAS24**

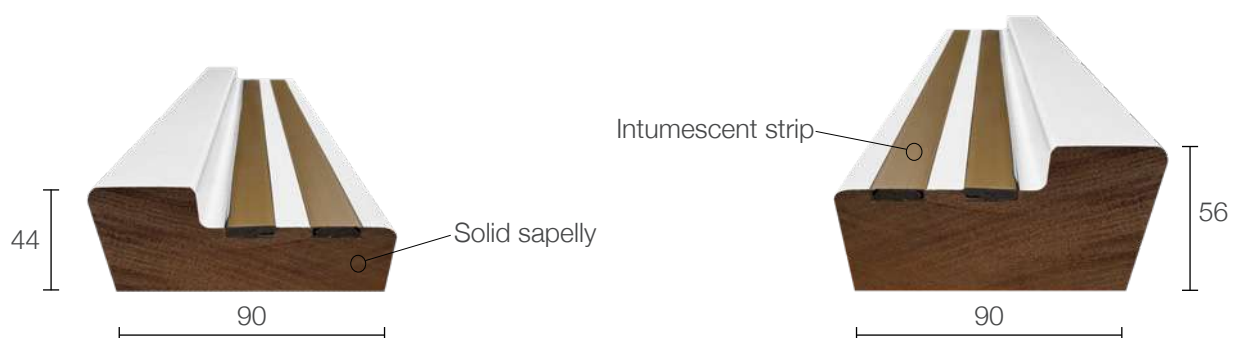

Adjustable settings

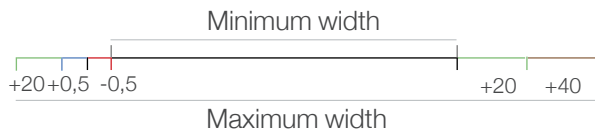

TADAP**

ARCHITRAVE 10

ARCHITRAVE 25

ARCHITRAVE 45

FRAME EXTENSION 70

FRAME EXTENSION 160

Door wing width



Frame width

Frame extension dimensions



Door WING width

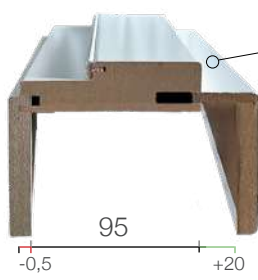

TADAP** + C.BATEX* 100 + WING 25

Wing 25

Wing 10



WING 10 + C.BATEX* 100 + WING 25

Wing 45

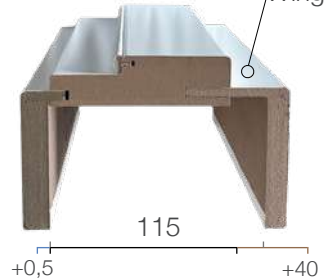

WING 10 + C.BATEX* 100 + WING 45

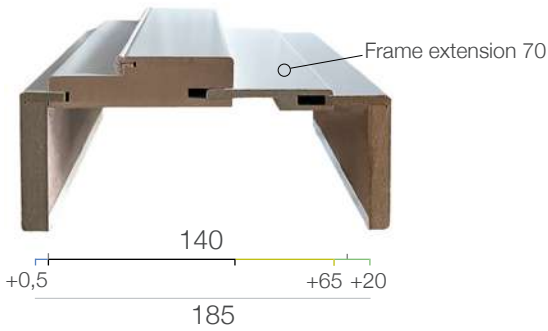

WING 10 + C.BATEX* 100 + FRAME EXTENSION 70 + WING 25

Frame extension 70

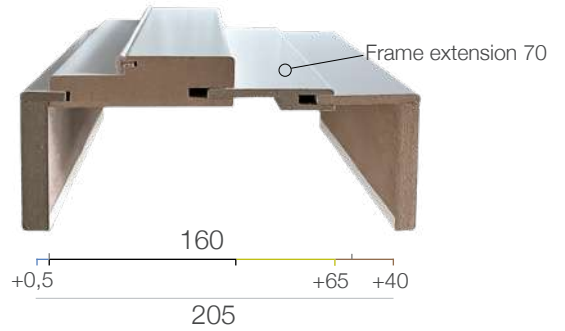

WING 10 + C.BATEX* 100 + FRAME EXTENSION 70 + WING 45

Frame extension 70

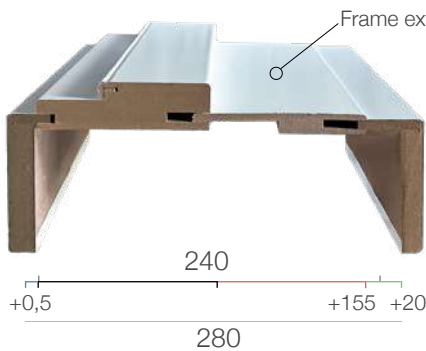

WING 10 + C.BATEX* 100 + FRAME EXTENSION 160 + WING 25

Frame extension 160

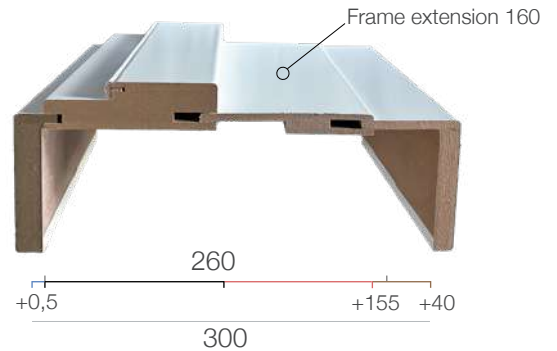

WING 10 + C.BATEX* 100 + FRAME EXTENSION 160 + WING 45

Frame extension 160

More configurations by increasing frame openings. Customisation options are available.
If an intermediate width is required (185, 195...), the wing 10 must be replaced with a TADAP**.
(*) Extendable frame. (**) Adjustable frame.

6.2. Ironmongery

We can adapt to your hardware preferences and deliver the doors with the hardware machining done, so that the client can install it later. We offer a wide range of hardware that can be used on fire-rated doors (FRD), and if a specific item is not available, we will work with our technical department and testing laboratories to have it included in the certifications.

Simply lock



1 Point lock



3 Point lock

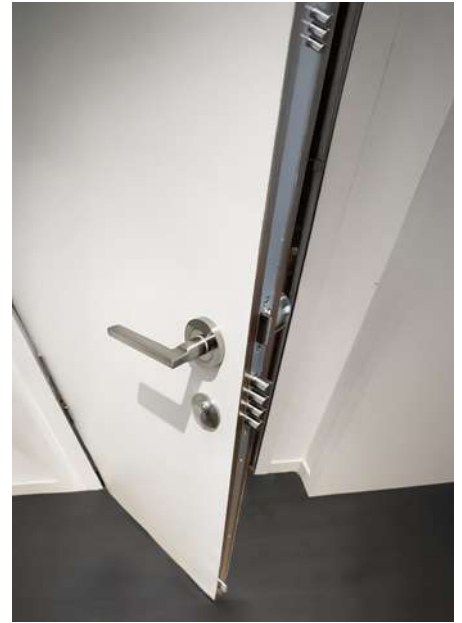

Brasilia



Recta



Uxama



Numancia 1



Numancia



Numancia R



Termancia



Termancia R



6.3. Other

Swing door



Sliding door



Shells



Covering with joint covers

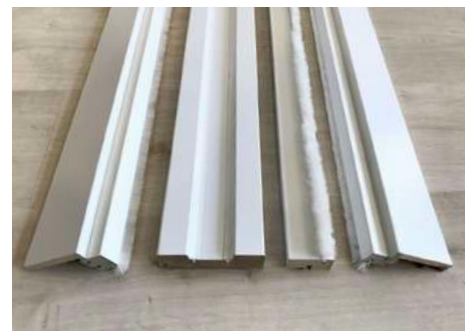

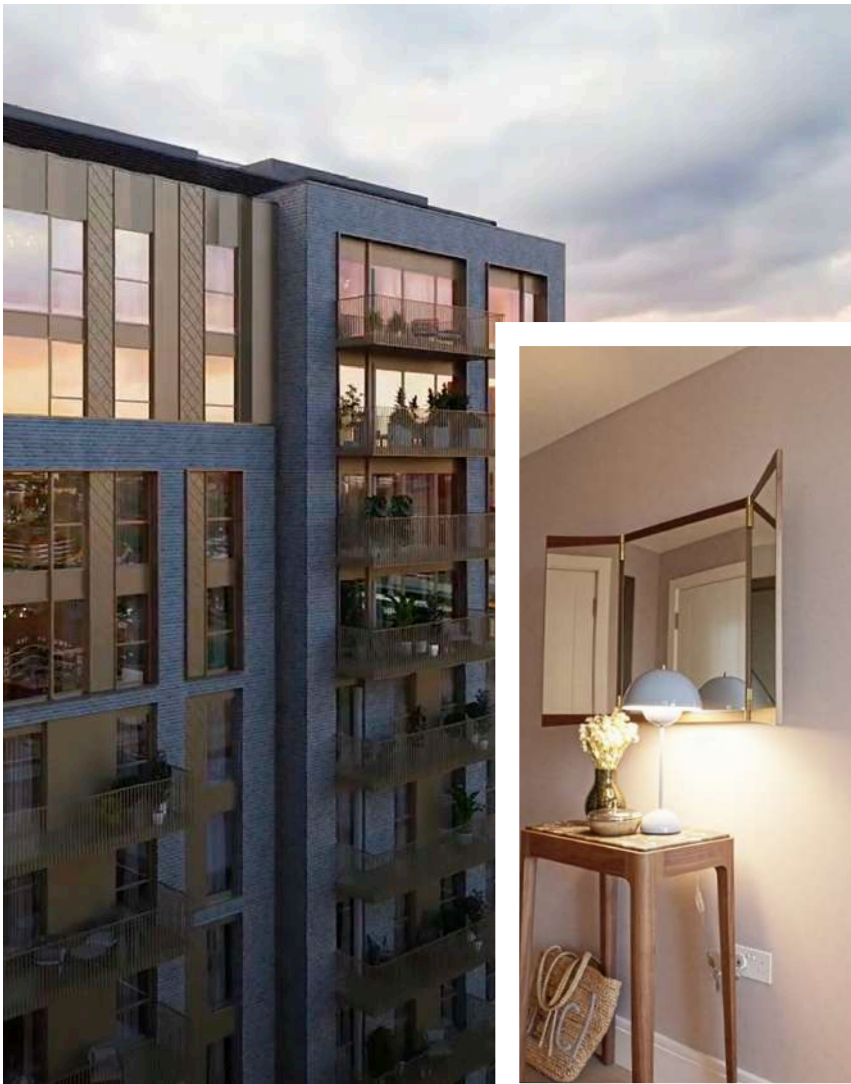

THE OVAL UNITED KINGDOM

- > 500 FD-60 PAS 24 entrance doors
- > 3,000 interior doors

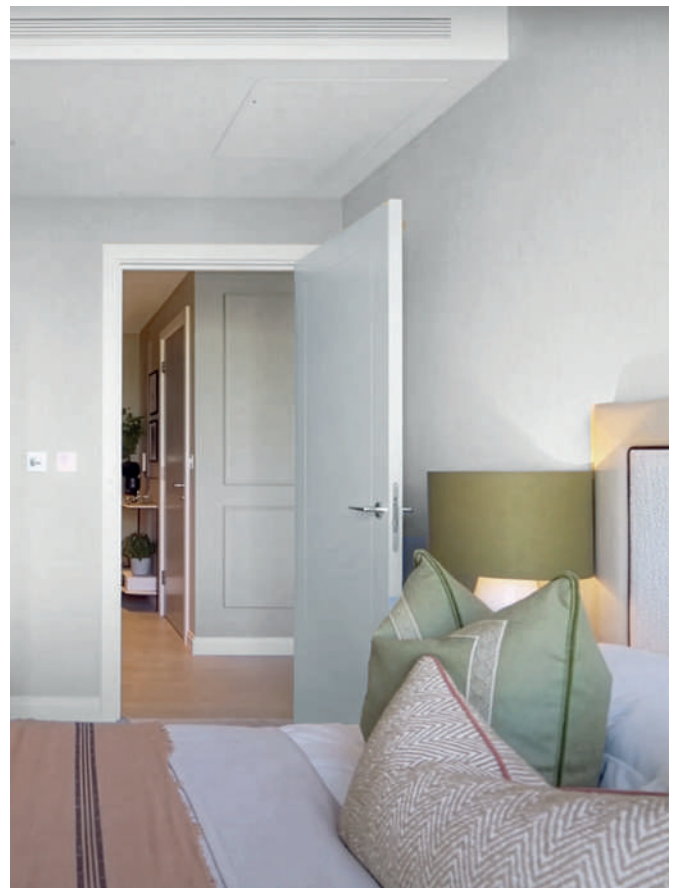



EUROCITY GIBRALTAR UNITED KINGDOM

- > 665 fire-rated door sets EI-30
- > 190 fire-rated door sets EI-60
- > 960 flush, rebated, glazed, sliding doors and more

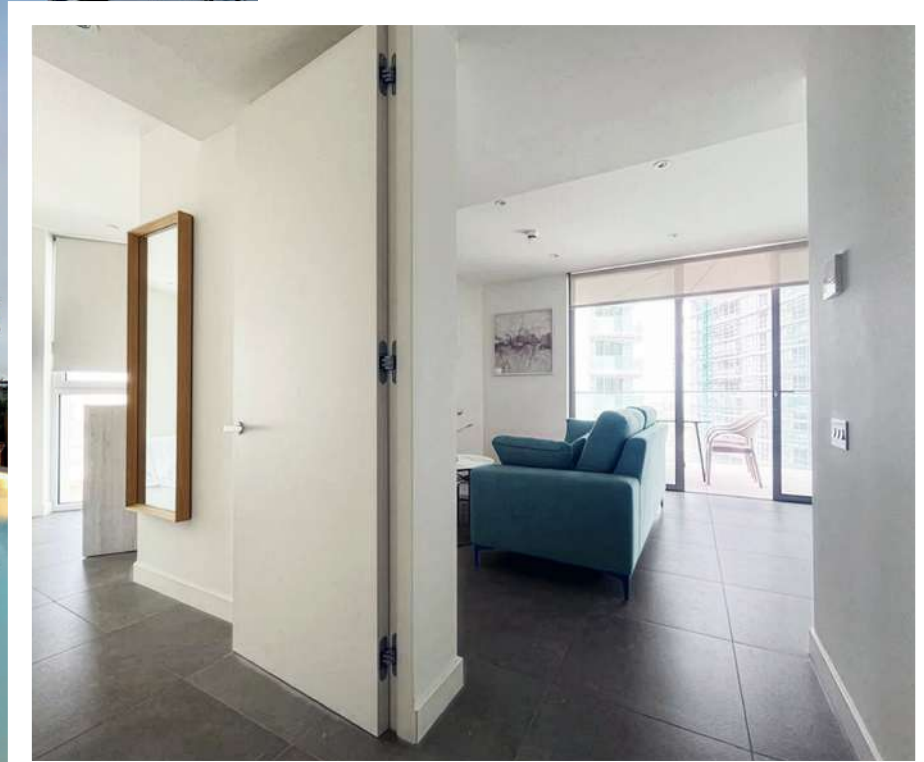

CIUDAD JARDÍN

SPAIN

- > 200 reinforced security door 30dB
- > 900 interior doors: solid, glazed, and sliding
- > 225 hinged and sliding wardrobes

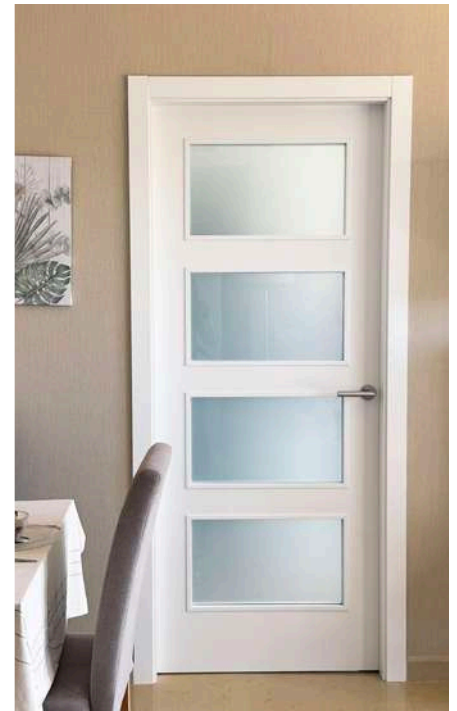
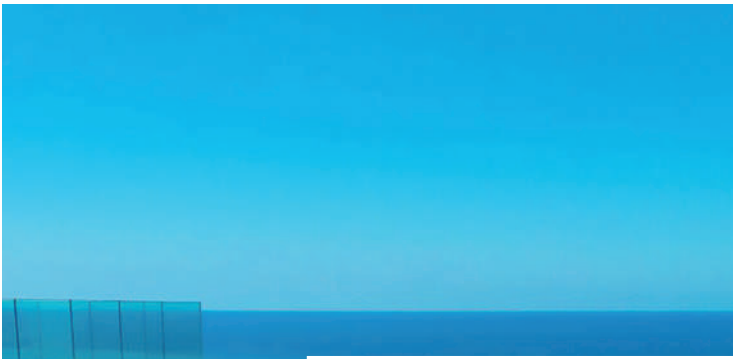

SAN FRANCISCO HOTEL

SPAIN

- > 80 entrance, double, armored and fire escape doors FD-30-60 36dB
- > 90 sliding and double swing doors

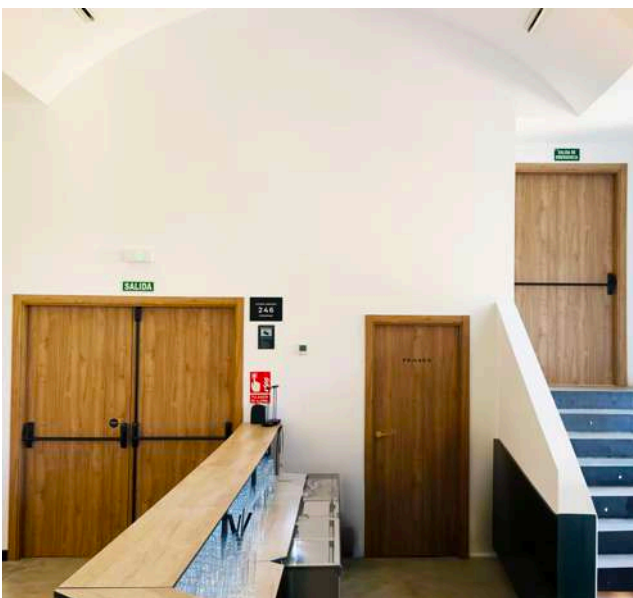
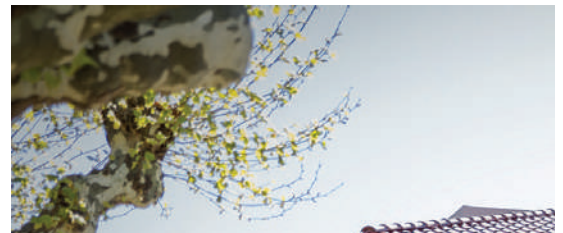



LA VIRGEN SPA HOTEL SPAIN

- > 30 fire-rated door sets EI-30 and EI-60
- > 50 hinged door sets with WPC frame support
- Panels, sliding doors and other wall coverings



AL RIMAL SAUDI ARABIA

- > 9,000 interior doors FD 30-60 32dB
- > 4,000 wardrobes

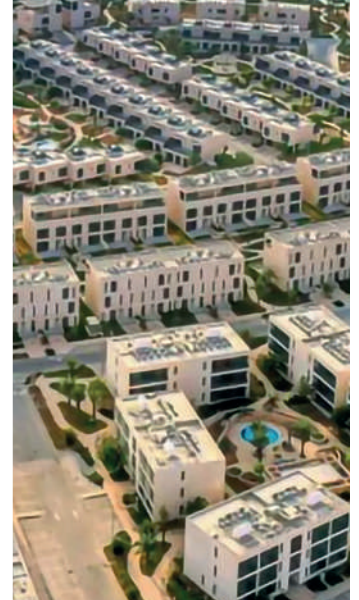

BANCAL HOTEL & SPA

SPAIN

- > 270 flush FD-30 doors with concealed frame
- > 40 FD-60 connecting doors
- > 120 sliding doors and double-leaf doors with vision portholes

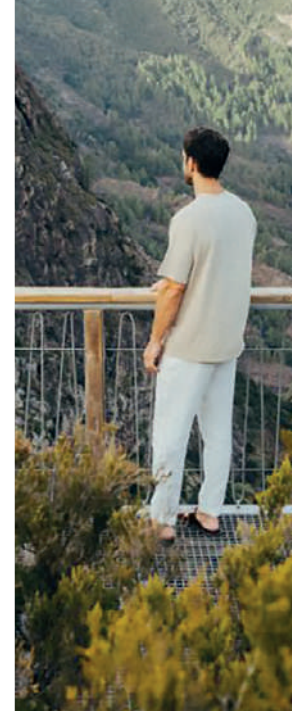

LA PALMERA STUDENT RESIDENCE BUILDING

SPAIN

- > 450 FD-30 entrance doors
- > 465 sliding and interior doors

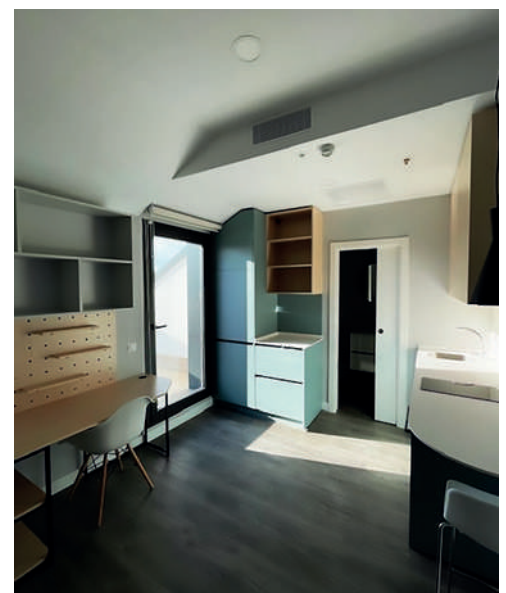

AKLA HOTEL

SPAIN

- > 30 fire-rated door sets EI-30 and EI-60 with concealed door closer
- > 30 single and double-leaf hinged door sets
- Double-leaf hinged door sets, swing doors with porthole and wardrobe fronts



CENTRAL BANK

ETHIOPIA

- > 400 internal doors
- > 50 doors EI-60





NORMA[®]

Tel. + 34 975 376 000

info@unidoors.eu
www.norma-doors.com



UNIDOORS

www.unidoors.eu

Paraje Quiñones, s/n
42140 San Leonardo de Yagüe
Soria - Spain

Autovía A4, km 64,5
45300 Ocaña
Toledo - Spain

The information, images, textures and all the contents in this price list are property of NORMA DOORS TECHNOLOGIES S.A. and UNIARTE DOORS S.L. therefore, any total or partial reproduction thereof without it's prior and express authorization is prohibited. The information may be modified or updated without prior notice. NORMA DOORS TECHNOLOGIES S.A. and UNIARTE DOORS S.L. Can also implement improvements and / or changes in products and / or content described in these pages at any time and without prior notice. The information provided is merely illustrative and referential, not advertising or contractual. All the characteristics of the products contained in this catalogue must be consulted prior to the conclusion of any operation. E251014